

Assembly Instructions

Hampstead Garden Natural Rattan
Standing Snuggler Egg Chair

521211-01-01
CLHNRSSEC

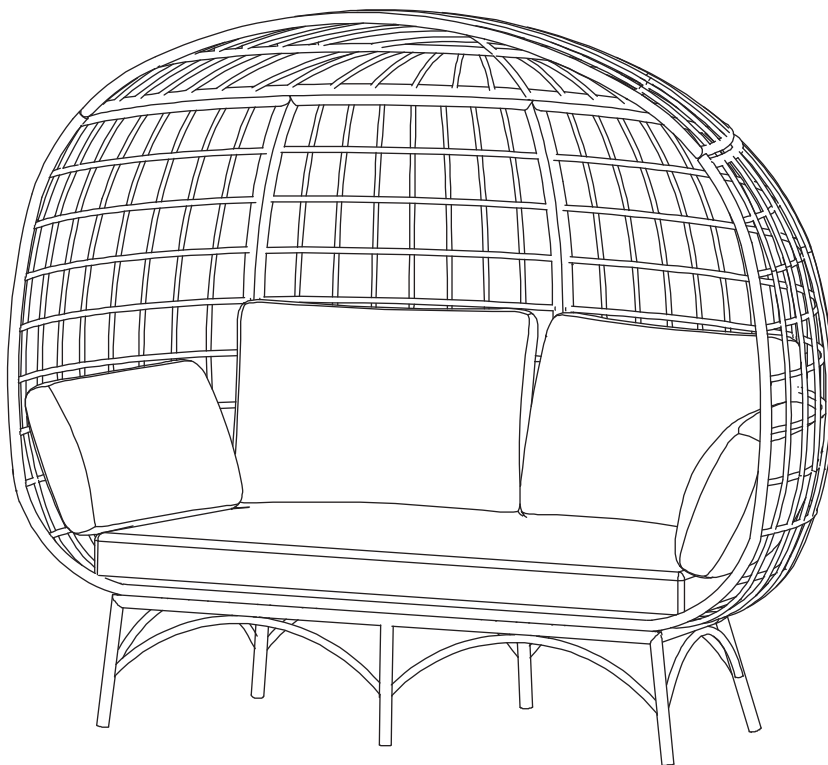

Keep these instructions for future reference

Assemble the furniture on a soft level surface to avoid damaging the furniture or your floor.

We recommend furniture be assembled near where they will be placed, to avoid moving the product unnecessarily once assembled.

If there is a need to move the furniture, please remove all loose items and have extra hands to help lift the furniture to the desired location. Dragging the furniture will damage both the furniture and the floor.

Regularly check and re-tighten (if necessary) all bolts on furniture that you have assembled yourself.

OUTDOOR FURNITURE CARE:

Clean using water and a soft brush.

Do not use aggressive cleaning agents and abrasives.

Remove any spilled food and drinks as soon as possible to prevent permanent staining.

Do not attempt to clean furniture in direct sunlight on a hot day.

Wash either in the morning or evening.

CUSHION

Sponge clean cushions only. For stubborn stains, fabric cleaners are commercially available. Please review application instructions on product before using on your cushions.

PARTS AND HARDWARE

Avoid using sharp objects such as a knife to cut open packing as you may accidentally damage the upholstery.

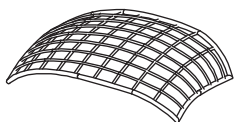

A:1PC

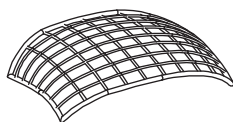

B:1PC

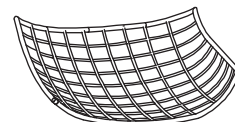

C:1PC

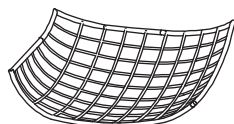

D:1PC

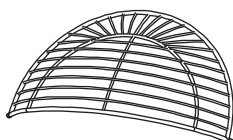

E:1PC



F:1PC

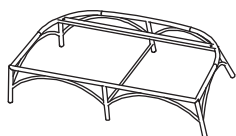

G:1PC

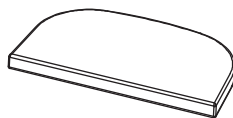

H:1PC

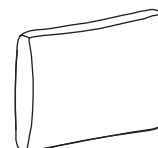

I:2PCS

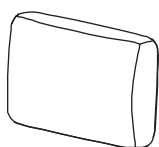

J:2PCS



M6*55

K:16PCS

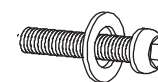

M6*40

L:6PCS

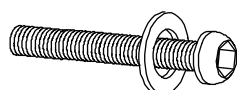

M6*60

M:3PCS

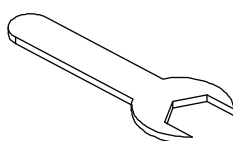

N:1PC

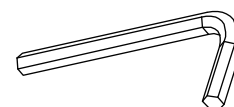

O:1PC

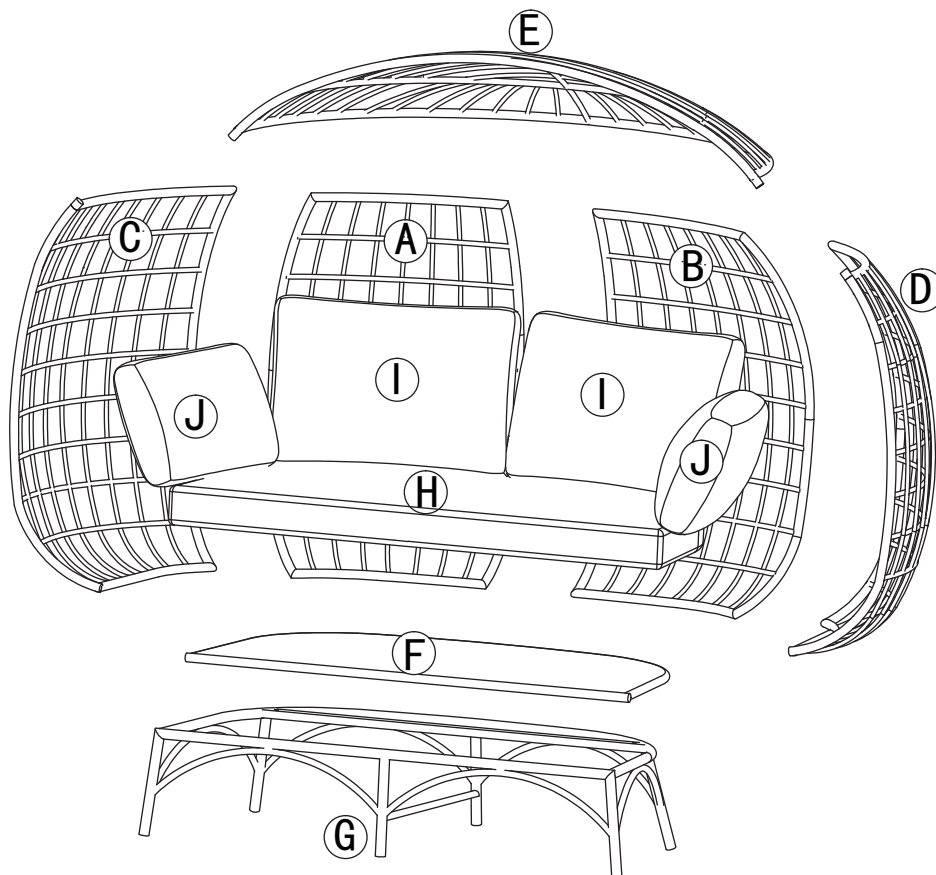

Fully tighten bolts only after all bolts on each leg are installed.

1

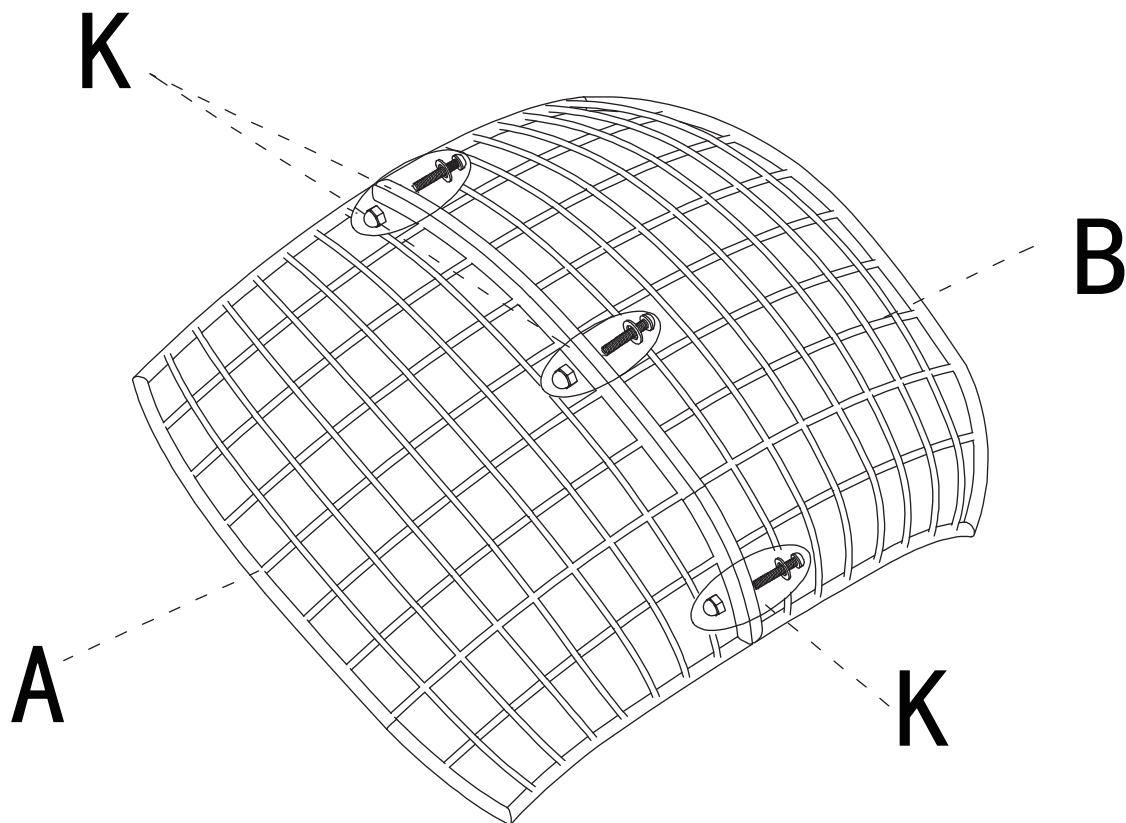

2

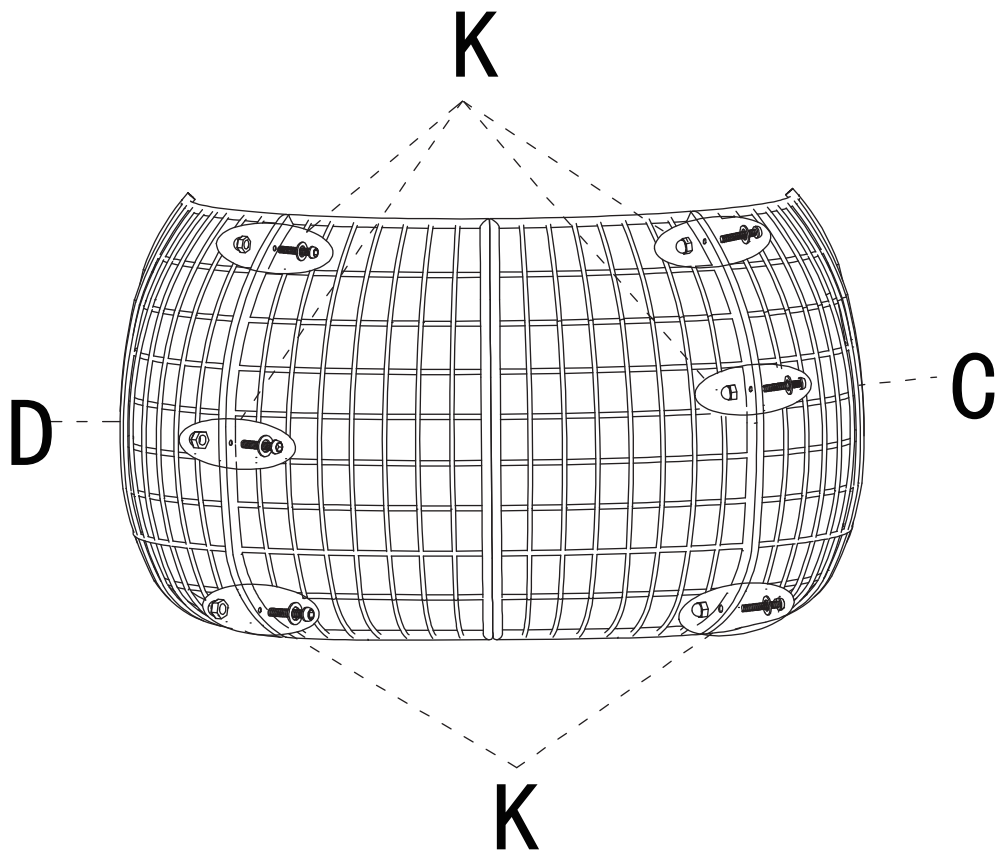

3

K/M

E

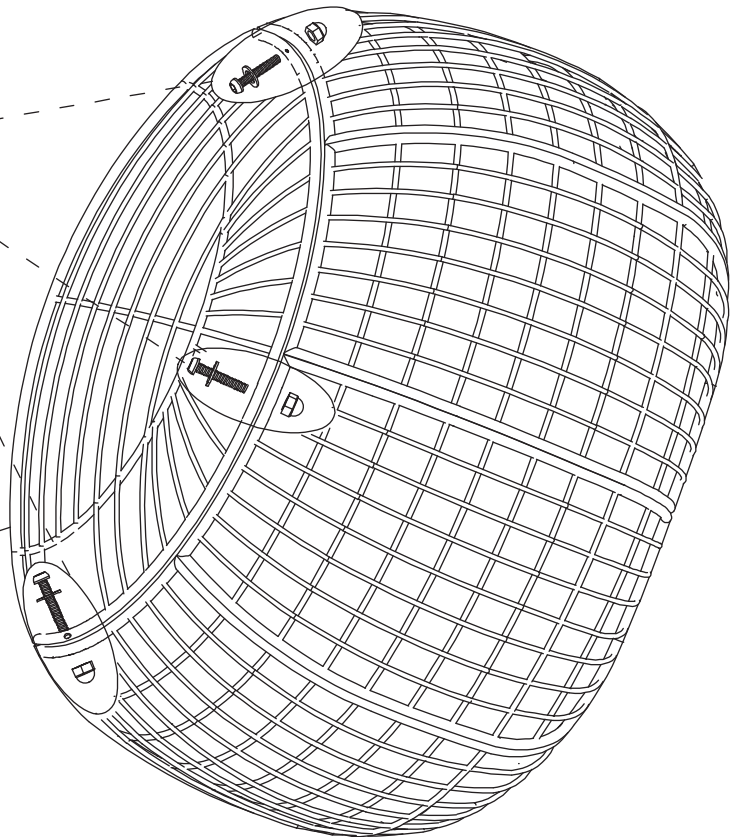

If Bolts K (M6*55mm) are not long enough, please replace them with Bolts M (M6* 60mm).

4

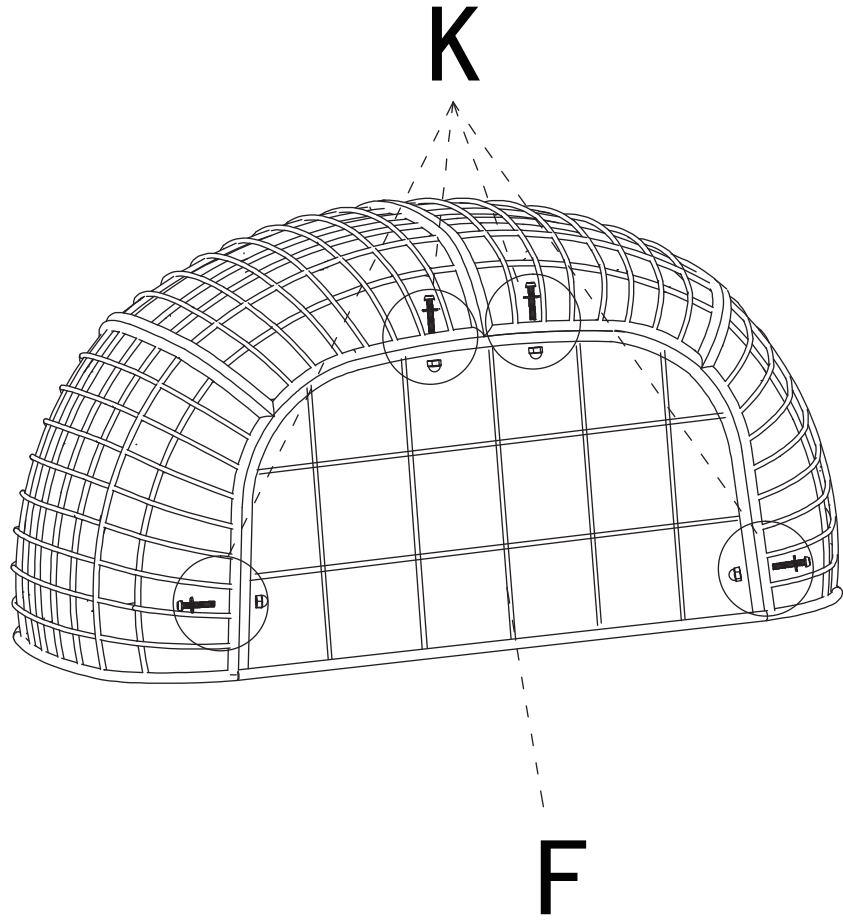

5

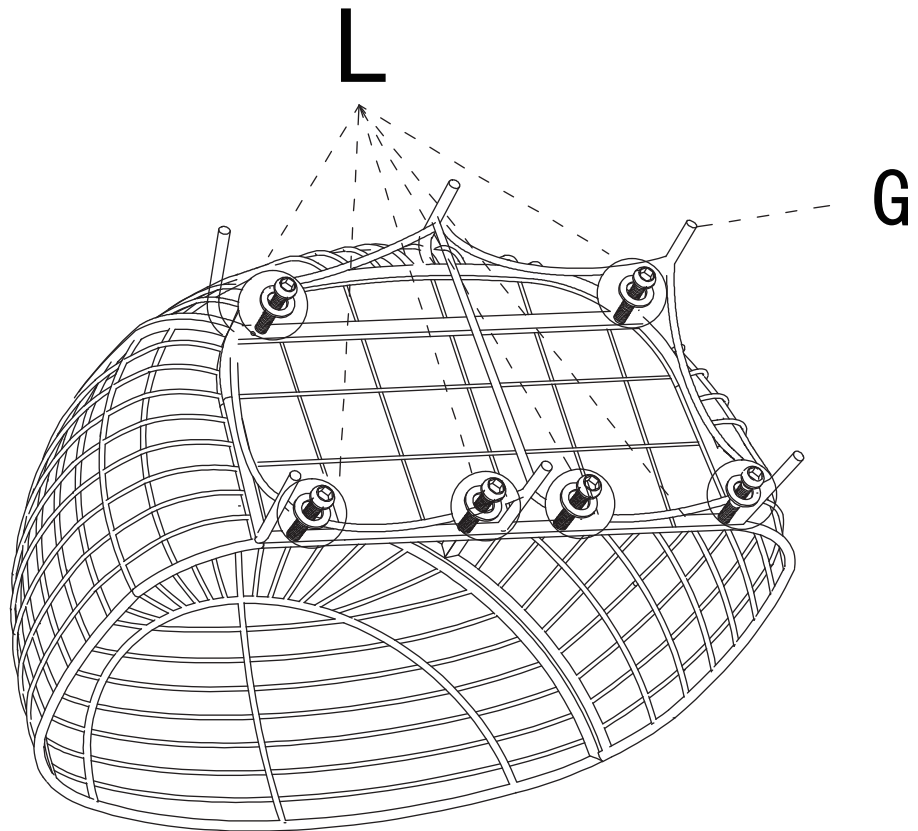

6

